

NOVAE[®]

DUAL MOBILITY CUPS



S U R G I C A L T E C H N I Q U E

serf
HIP

 C O N T E N T

PRESENTATION OF THE DUAL
MOBILITY CONCEPT 4

THE RANGE OF IMPLANTS 8

IMPLANTS REFERENCES 9

SURGICAL TECHNIQUE 12

INSTRUMENTATION..... 24

ACCESS TO THE DIGITAL
INSTRUCTION FOR USE 28



PRESENTATION OF THE DUAL MOBILITY CONCEPT

The **NOVAE**[®] range of acetabular cups is intended for primary total hip arthroplasty and revision cases, with and without cement.

NOVAE[®] acetabular cups are based on the dual mobility concept invented in 1974 by Prof. Gilles BOUSQUET of the Saint Etienne University Hospital and Mr André RAMBERT, founder of SERF.

The consideration of 2 fundamental orthopaedic principles led to developing this concept:

- Sir Charnley's low friction principle which recommends using a significant thickness of polyethylene and a femoral head \varnothing 22.2 mm to reduce wear of the friction torque.
- McKee-Farrar's principle which recommends using a femoral head with a large diameter to reduce the risk of dislocation and prosthetic instability.

The dual mobility therefore consists of a first mobility which is the mobility of the head in the liner (small articulation), and a second mobility (large articulation) which corresponds to the mobility of the liner in the cup as shown below:

THE SMALL ARTICULATION (OR 1ST MOBILITY)



THE LARGE ARTICULATION (OR 2ND MOBILITY)

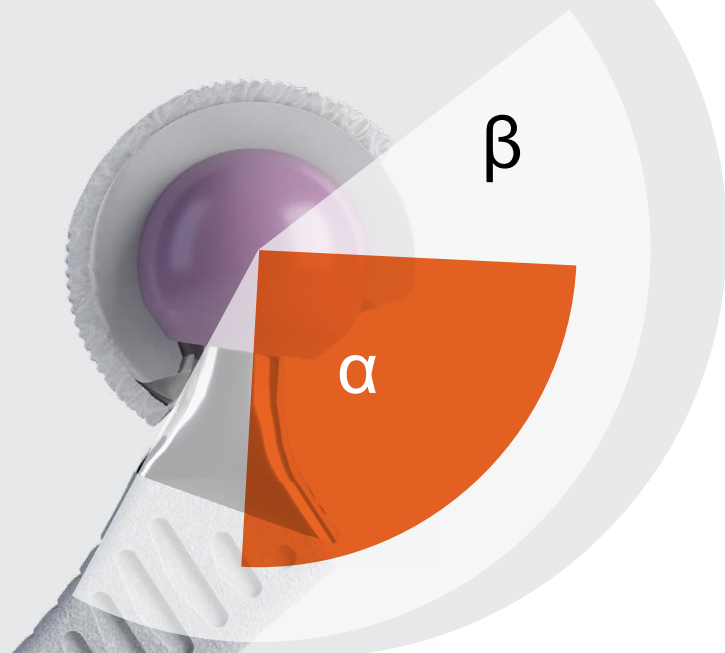

This characteristic allows to significantly increase the «jump distance» (distance between the top of the femoral head and the outermost point of the cup) and thereby reduce the risk of dislocation, whether by decoaptation of the articular surfaces or by impingement, through contact between the neck of the prosthesis and the edge of the metal cup.

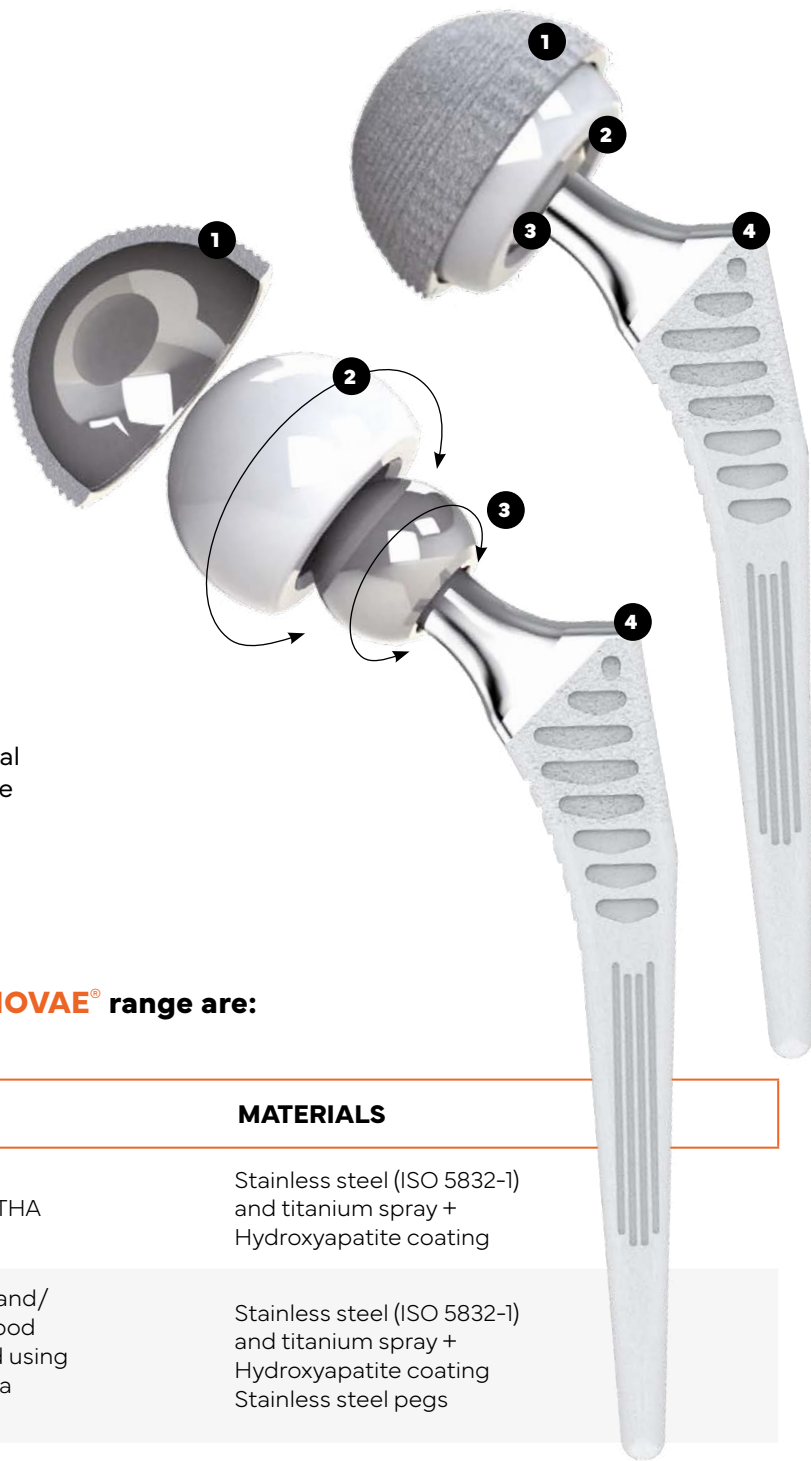

A total hip replacement with a **NOVAE**® dual mobility cup is made up of the following:

- 1 The cup made of forged stainless steel
- 2 The mobile liner in polyethylene
- 3 The metal or ceramic femoral head
- 4 The femoral stem that must have a neck that is preferably smooth and bright polished without any sharp corners because of the normal but repetitive contact between the polyethylene liner and the prosthetic neck

The different implants that make up the **NOVAE**® range are:

DESIGNATION	IMPLANT TYPE	MATERIALS
NOVAE ® SUNFIT TH	Cementless cup for primary THA	Stainless steel (ISO 5832-1) and titanium spray + Hydroxyapatite coating
NOVAE ® E TH	Cementless cup for primary and/ or small revision THA with tripod attachment system obtained using 2 pegs and a flange in which a fixation screw is used	Stainless steel (ISO 5832-1) and titanium spray + Hydroxyapatite coating Stainless steel pegs
NOVAE ® COPTOS TH	Cementless cup for revision THA with two pegs, one hook and two flanges in which 4 fixation screws can be used	Stainless steel (ISO 5832-1) and titanium spray + Hydroxyapatite coating Stainless steel pegs
NOVAE ® STICK	Cemented cup	Stainless steel (ISO 5832-1)
CI E liner	Dual mobility liner (common to all Novae® cups)	Polyethylene UHMWPE (ISO 5834-2)
VCI screw	Cortical screw Ø 5 mm	Stainless steel (ISO 5832-1)
XPEO-E liner	Dual mobility liner (common to all Novae® cups)	Vitamin E-stabilized highly crosslinked UHMWPE

NOVAE® ACETABULAR CUP CHARACTERISTICS

All of the **NOVAE®** acetabular cups are hemispherical with a 3 mm cylinder added to form a cylinder-spherical type shape.

They gradually flatten from the top following a wide radius (0.5 mm maximum), which contributes to absorbing the stress at the bottom of the cup on final impactation.

The internal surface of the cups is completely polished to allow articulation of the dual mobility.

The cups without cement have an equatorial press-fit to encourage primary fixation of the implant to the bone. The secondary fixation is provided by the dual coating of titanium spray (thickness $150 \pm 30 \mu\text{m}$) and HA coating (thickness $70 \pm 20 \mu\text{m}$), on the outer surface of the cups without cement.

The **NOVAE® STICK** cup comes with a single use cup impactor directly in its packaging.

3 mm CYLINDER

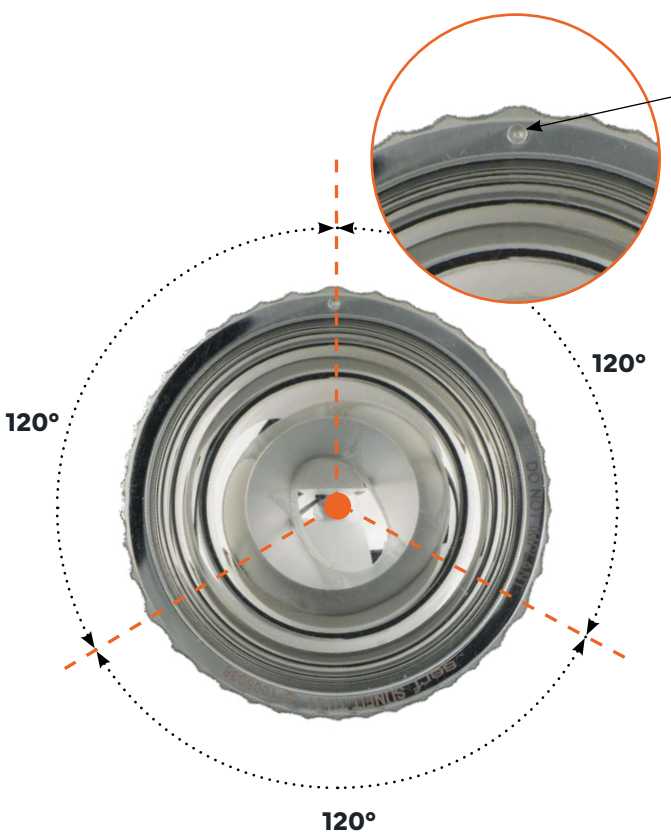
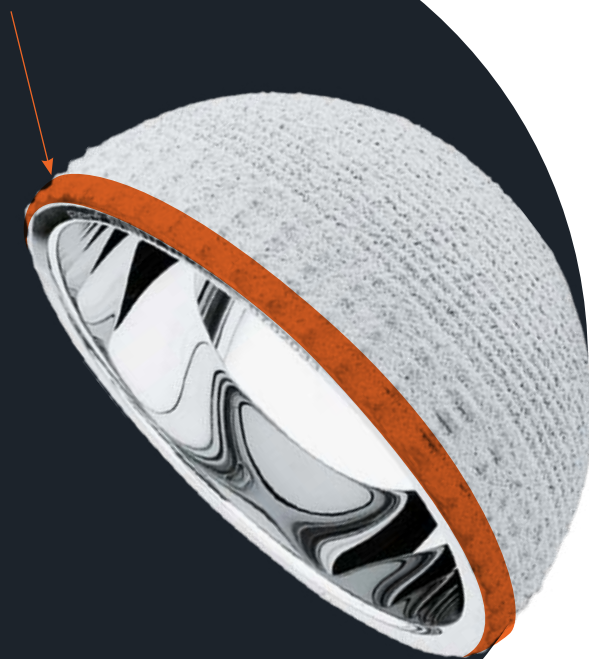

MECHANICAL MARKER

NOVAE® SUNFIT TH

The **NOVAE® SUNFIT TH** cup is an acetabular implant without cement intended for primary total hip replacement (THR).

To ensure primary fixation, the cup has 3 points (a few tenths of millimetres higher) that divide the acetabular cup into three 120° segments. The equatorial press-fit is distributed around these 3 points. The press-fit's height and thickness change according to the cup's diameter (minimum 1.2 mm, maximum 2.1 mm).

A mechanical marker is placed on the implant edge so that the point to be attached to the ilium can be located.

NOVAE® E TH

The **NOVAE® E TH** cup is an acetabular implant without cement intended for primary total hip replacement (THR).

To ensure primary fixation, the **NOVAE® E TH** cup has both an equatorial press-fit and a tripod attachment system: 1 peg in the ischium, 1 peg in the pubis, and 1 cortical screw in the ilium through the malleable flange. This concept of 3 anchoring points was devised by Prof. Gilles BOUSQUET to ensure primary stability during rotation and pull-out of the **NOVAE® E TH** acetabular cup.



NOVAE® COPTOS TH

The **NOVAE® COPTOS TH** cup is an acetabular implant intended for acetabular reconstructions without cement. Primary fixation of the **NOVAE® COPTOS TH** is obtained by equatorial press-fit complemented by 2 pegs, 2 flanges (which can place up to 4 fixation screws in the ilium), and 1 hook. The hook, previously placed in the obturator hole, allows for anatomical repositioning and provides additional mechanical support.

The 2 flanges are malleable and breakable to adapt to different cases of acetabular reconstructions.



NOVAE® STICK

The **NOVAE® STICK** cup is an acetabular implant intended to be attached to the bone with surgical cement.

The external surface has raised reliefs that allow for the evacuation of excess cement and promote stability when it is polymerised.



THE RANGE OF IMPLANTS



NOVAE® SUNFITTH
Ø 43 TO 69 mm



NOVAE® ETH
Ø 41 TO 69 mm

The liners are compatible with all of the **NOVAE®** cups, respecting the size they will be used with. In primary total hip replacement, using Ø 22.2 heads up to size 51 inclusive allows a considerable thickness of UHMWPE.



NOVAE® COPTOSTH
Ø 43 TO 69 mm



NOVAE® STICK
Ø 43 TO 63 mm

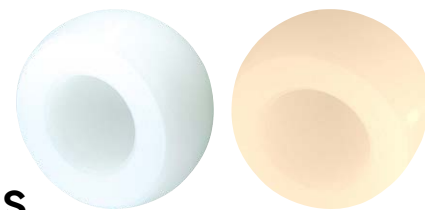

CI E AND XPEO-E LINERS

THICKNESS IN mm

SIZE	HEAD 22.2 mm	HEAD 28 mm
Ø 41	6.1	/
Ø 43	6.9	/
Ø 45	7.9	/
Ø 47	8.9	6.1
Ø 49	9.9	7
Ø 51	10.9	8
Ø 53	11.9	9
Ø 55	12.8	9.9
Ø 57	13.8	10.9
Ø 59	14.8	11.9
Ø 61	15.8	12.9
Ø 63	16.8	13.9
Ø 65	17.8	14.9
Ø 67	18.8	15.9
Ø 69	19.8	16.9



VCI CORTICAL SCREW
Ø 5 mm
LENGTH 20 TO 70 mm

IMPLANTS REFERENCES



NOVAE® SUNFIT TH



NOVAE® E TH



REFERENCES	DESIGNATION	SIZE
RM50200043	SUNFIT TH 43	Ø 43
RM50200045	SUNFIT TH 45	Ø 45
RM50200047	SUNFIT TH 47	Ø 47
RM50200049	SUNFIT TH 49	Ø 49
RM50200051	SUNFIT TH 51	Ø 51
RM50200053	SUNFIT TH 53	Ø 53
RM50200055	SUNFIT TH 55	Ø 55
RM50200057	SUNFIT TH 57	Ø 57
RM50200059	SUNFIT TH 59	Ø 59
RM50200061	SUNFIT TH 61	Ø 61
RM50200063	SUNFIT TH 63	Ø 63
RM50200065	SUNFIT TH 65	Ø 65
RM50200067	SUNFIT TH 67	Ø 67*
RM50200069	SUNFIT TH 69	Ø 69*

REFERENCES	DESIGNATION	SIZE
RM50100041	NOVAE® E 41 TH	Ø 41*
RM50100043	NOVAE® E 43 TH	Ø 43
RM50100045	NOVAE® E 45 TH	Ø 45
RM50100047	NOVAE® E 47 TH	Ø 47
RM50100049	NOVAE® E 49 TH	Ø 49
RM50100051	NOVAE® E 51 TH	Ø 51
RM50100053	NOVAE® E 53 TH	Ø 53
RM50100055	NOVAE® E 55 TH	Ø 55
RM50100057	NOVAE® E 57 TH	Ø 57
RM50100059	NOVAE® E 59 TH	Ø 59
RM50100061	NOVAE® E 61 TH	Ø 61
RM50100063	NOVAE® E 63 TH	Ø 63
RM50100065	NOVAE® E 65 TH	Ø 65
RM50100067	NOVAE® E 67 TH	Ø 67*
RM50100069	NOVAE® E 69 TH	Ø 69*

NOVAE® COPTOS TH



REFERENCES	DESIGNATION	SIZE
RM50300043	COPTOS 43 TH	Ø 43
RM50300045	COPTOS 45 TH	Ø 45
RM50300047	COPTOS 47 TH	Ø 47
RM50300049	COPTOS 49 TH	Ø 49
RM50300051	COPTOS 51 TH	Ø 51
RM50300053	COPTOS 53 TH	Ø 53
RM50300055	COPTOS 55 TH	Ø 55
RM50300057	COPTOS 57 TH	Ø 57
RM50300059	COPTOS 59 TH	Ø 59
RM50300061	COPTOS 61 TH	Ø 61
RM50300063	COPTOS 63 TH	Ø 63
RM50300065	COPTOS 65 TH	Ø 65
RM50300067	COPTOS 67 TH	Ø 67*
RM50300069	COPTOS 69 TH	Ø 69*

NOVAE® STICK



REFERENCES	DESIGNATION	SIZE
RM50400043	NOVAE® STICK 43	Ø 43
RM50400045	NOVAE® STICK 45	Ø 45
RM50400047	NOVAE® STICK 47	Ø 47
RM50400049	NOVAE® STICK 49	Ø 49
RM50400051	NOVAE® STICK 51	Ø 51
RM50400053	NOVAE® STICK 53	Ø 53
RM50400055	NOVAE® STICK 55	Ø 55
RM50400057	NOVAE® STICK 57	Ø 57
RM50400059	NOVAE® STICK 59	Ø 59
RM50400061	NOVAE® STICK 61	Ø 61
RM50400063	NOVAE® STICK 63	Ø 63



VCI CORTICAL SCREW Ø 5 mm

REFERENCES	DESIGNATION	REFERENCES	DESIGNATION
RM70100520	VCI 5 X 20	RM70100550	VCI 5 X 50
RM70100525	VCI 5 X 25	RM70100555	VCI 5 X 55
RM70100530	VCI 5 X 30	RM70100560	VCI 5 X 60
RM70100535	VCI 5 X 35	RM70100565	VCI 5 X 65
RM70100540	VCI 5 X 40	RM70100570	VCI 5 X 70
RM70100545	VCI 5 X 45		

*Optional sizes available on request with a specific instrumentation set.

CI E LINER



REFERENCES	LINER 22.2	REFERENCES	LINER 28
RM54202241	CI 41/22.2 E*	/	/
RM54202243	CI 43/22.2 E*	/	/
RM54202245	CI 45/22.2 E	/	/
RM54202247	CI 47/22.2 E	RM54202847	CI 47/28 E
RM54202249	CI 49/22.2 E	RM54202849	CI 49/28 E
RM54202251	CI 51/22.2 E	RM54202851	CI 51/28 E
RM54202253	CI 53/22.2 E	RM54202853	CI 53/28 E
RM54202255	CI 55/22.2 E	RM54202855	CI 55/28 E
RM54202257	CI 57/22.2 E	RM54202857	CI 57/28 E
RM54202259	CI 59/22.2 E	RM54202859	CI 59/28 E
RM54202261	CI 61/22.2 E	RM54202861	CI 61/28 E
RM54202263	CI 63/22.2 E	RM54202863	CI 63/28 E
RM54202265	CI 65/22.2 E	RM54202865	CI 65/28 E
RM54202267	CI 67/22.2 E*	RM54202867	CI 67/28 E*
RM54202269	CI 69/22.2 E*	RM54202869	CI 69/28 E*



XPEO-E LINER

REFERENCES	LINER 22.2	REFERENCES	LINER 28
RM51452241	NOVAE XPEO-E LINER 41/22.2*	/	/
RM51452243	NOVAE XPEO-E LINER 43/22.2	/	/
RM51452245	NOVAE XPEO-E LINER 45/22.2	/	/
RM51452247	NOVAE XPEO-E LINER 47/22.2	RM51452847	NOVAE XPEO-E LINER 47/28
RM51452249	NOVAE XPEO-E LINER 49/22.2	RM51452849	NOVAE XPEO-E LINER 49/28
RM51452251	NOVAE XPEO-E LINER 51/22.2	RM51452851	NOVAE XPEO-E LINER 51/28
RM51452253	NOVAE XPEO-E LINER 53/22.2	RM51452853	NOVAE XPEO-E LINER 53/28
RM51452255	NOVAE XPEO-E LINER 55/22.2	RM51452855	NOVAE XPEO-E LINER 55/28
RM51452257	NOVAE XPEO-E LINER 57/22.2	RM51452857	NOVAE XPEO-E LINER 57/28
RM51452259	NOVAE XPEO-E LINER 59/22.2	RM51452859	NOVAE XPEO-E LINER 59/28
RM51452261	NOVAE XPEO-E LINER 61/22.2	RM51452861	NOVAE XPEO-E LINER 61/28
RM51452263	NOVAE XPEO-E LINER 63/22.2	RM51452863	NOVAE XPEO-E LINER 63/28
RM51452265	NOVAE XPEO-E LINER 65/22.2	RM51452865	NOVAE XPEO-E LINER 65/28
RM51452267	NOVAE XPEO-E LINER 67/22.2*	RM51452867	NOVAE XPEO-E LINER 67/28*
RM51452269	NOVAE XPEO-E LINER 69/22.2*	RM51452869	NOVAE XPEO-E LINER 69/28*

*Optional sizes available on request with a specific instrumentation set

SURGICAL TECHNIQUE

1 PREOPERATIVE PLANNING

To ensure that the implants are correctly positioned, an X ray evaluation using the implants' templates supplied (or using the available planning software) is recommended.

This planning must be used to select the adequate acetabular cup to implant in terms of size and orientation.

3 TRIALS

How to use the gripper / implant impactor handle

MP010 : The minimally invasive gripper handle is curved to adapt to the anterior hip approaches and minimally invasive surgeries. It is used to hold the trial cup and to guide and impact the definitive implant.

- 1 Position unlocked to maximum needed to put the cup holder impactor in place
- 2 Neutral position
- 3 Locked position: to be used to grip the trial cup and/or the definitive implant.

MP020L : Straight gripper handle can be adapted to the different surgical approach. It has an anvil that can be tightened or loosened to release or maintain the trial and definitive implant.

2 ACETABULAR PREPARATION

The acetabular reamers supplied in the **NOVAE**[®] instrumentation set are identical in shape to the cup and therefore have a 3 mm cylinder that must be inserted right into the bone during the acetabular preparation.

To avoid any risk of imperfect preparation of the acetabulum and incomplete insertion of the definitive cup, we do not recommend using any other acetabular reamers than the ones provided with the **NOVAE**[®] instrument set.

The true bottom of the acetabulum is exposed by initially reaming with a small-sized reamer.

Reaming at 45° is then performed using a reamer at least 2 mm smaller than the femoral head diameter.

The final reamer should be the same diameter as the selected cup diameter.

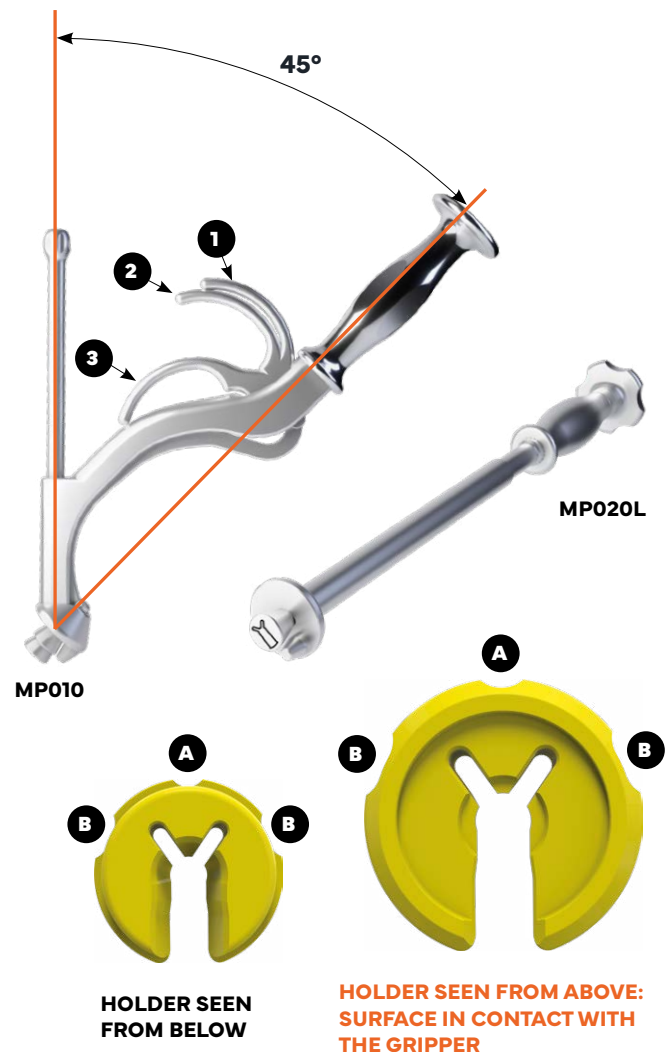

Use of the acetabular cup holder

When the cup holder impactor is used with the gripper handle, it ensures that the trial and definitive acetabular cups are firmly gripped.

It has the following characteristics:

- A** A visualisation notch that need to be positionned relative to the marker on the edge of the **NOVAE**® cups.
- B** 2 viewing windows used to identify how far the trial cup or definitive implant has been impacted into the acetabulum.

To set the cup holder impactor on the gripper handle (set to the diameter of the last reamer used) :

- **MP010** : The lever must be opened to its maximum release (position **1**).
- **MP020L** : The anvil must be loosened to insert the holder

Use the positioning marker drawn on the gripper to mount the cup holder impactor at the front.

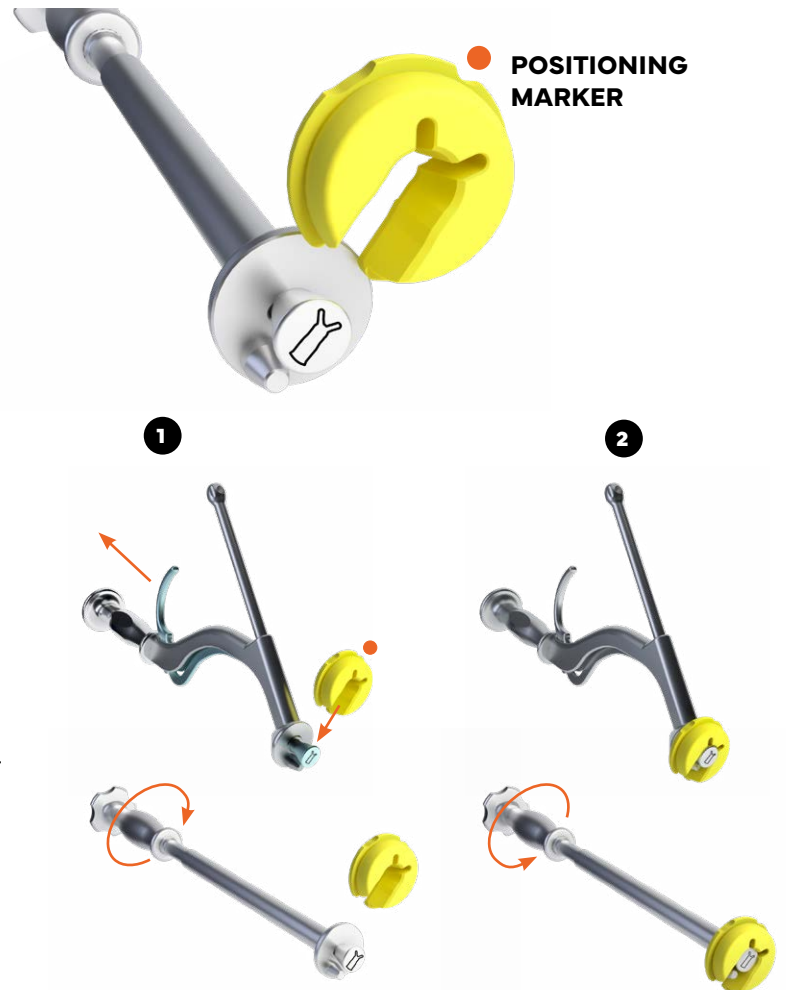

Positioning the trial acetabular cup

The trial acetabular cup is the same for all the **NOVAE**® cups.

Trial implant characteristics:

- A** A notch showing position of the flange for the **NOVAE**® **E TH** cup.
When putting it on the gripper handle, it must be positioned in front of the visualisation notch on the cup holder impactor.
- B** A peripheral exterior groove materialising the 3 mm cylinder that completes the hemisphere.
- C** Two holes showing peg position for acetabular cups with pegs.
- D** Lower opening to situate the acetabular teardrop position.
- E** Two upper engraved lines showing the position of the 2 flanges for the **NOVAE**® **COPTOS TH** cup.
- F** Position marker for **NOVAE**® **COPTOS TH** cup hook.

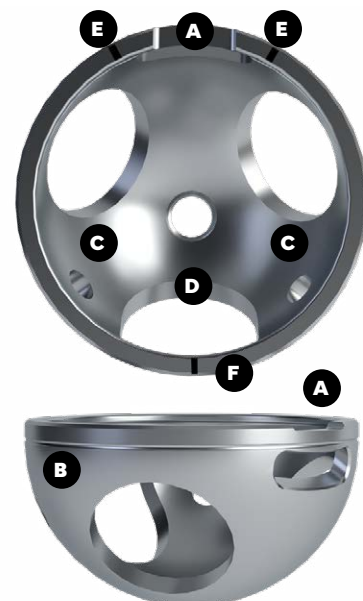

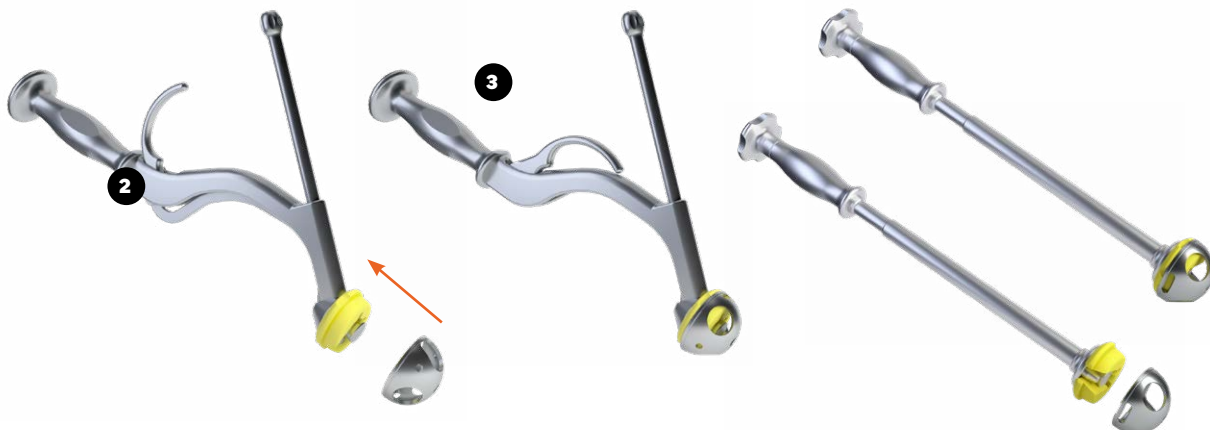

- **MP010:** Put the trial cup on the cup holder impactor (position **2**) then lock the handle by closing the lever (position **3**).
- **MP020L:** Put the trial cup on the cup holder impactor then lock the gripper by tightening the anvil.

Impact this unit into the acetabulum respecting the orientation and anteversion determined during the pre-operative planning. It is important to take the markers on the trial implant into consideration in accordance with the cup that will be implanted (markers A to E explained on the previous page).

The trial implant has no equatorial press-fit. If the trial implant behaves correctly in the acetabulum, the size of the definitive implant can be confirmed.

At this stage, reduction trials can be carried out in the trial implant.

For this, it just needs to be left in the acetabulum and the gripper handle removed.

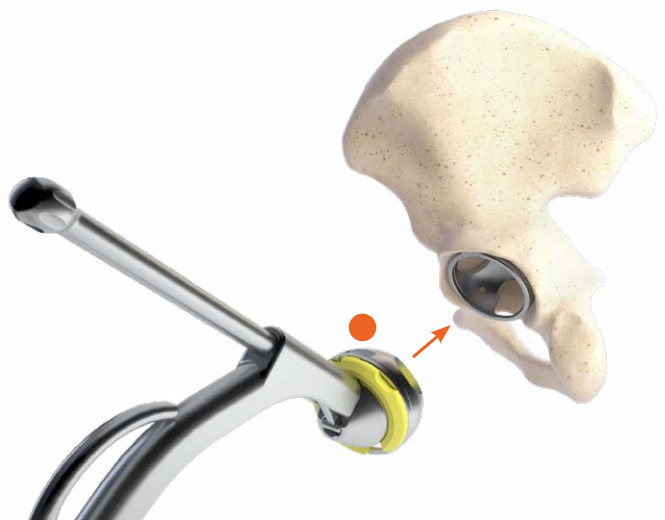

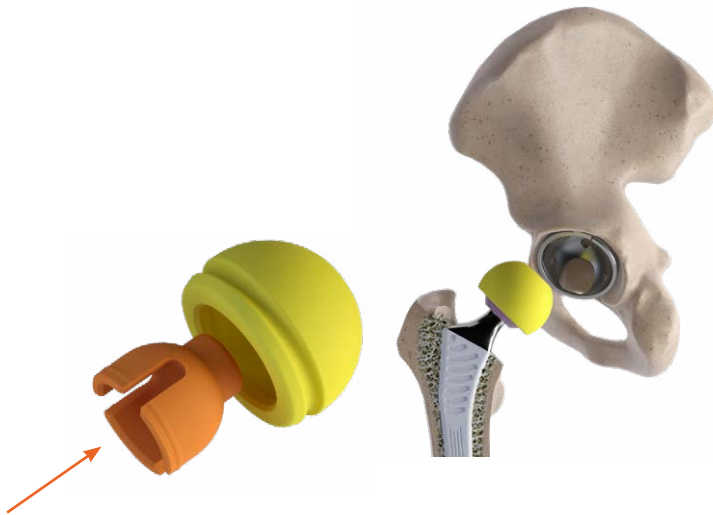

Trial evaluation

The yellow trial liners are used with the Ø 28 mm heads. To perform trials with Ø 22.2 mm heads, a yellow trial liner must be combined with the orange Ø 22.2/Ø 28 trial liner adaptor.

The trials can be carried out using the trial head or the definitive femoral head.

Mount the trial liner on the trial femoral head (or the definitive one on the stem or on the trial neck broach).

Then carry out the hip reduction by applying an axial traction to the leg and by pushing the liner into the bottom of the acetabular cup using the dual mobility impactor tip attached to its impactor handle.

Carry out tests for stability, angular range, and leg length.

Once the diameter and length of the neck have been determined, remove the trial liner.

4 SUNFIT TH IMPLANTATION

Mount the **NOVAE® SUNFIT TH** cup on the gripper (already fitted with the right-size cup holder impactor for the definitive implant).

Present the **NOVAE® SUNFIT TH** cup in front of the acetabular cavity.

The notch on the cup holder impactor makes it possible to see the marker on the side of the implant that must be positioned towards the roof of the acetabulum.

The inclination/abduction of 45° and the anteversion (between 15 and 20°) should be checked prior starting impaction.

Proceed to the impaction of the implant and then open the handle to remove the gripper. To complete impaction of the implant, the straight impactor can be used with the cup impactor tip.

Protect the polished surface with a sterile pad.

It is not recommended to correct the inclination/abduction of the cup after impaction, however it must be fully seated in the acetabulum. To ensure this, there is a notch in the cup impactor tip so that pressure can be put on its edge.

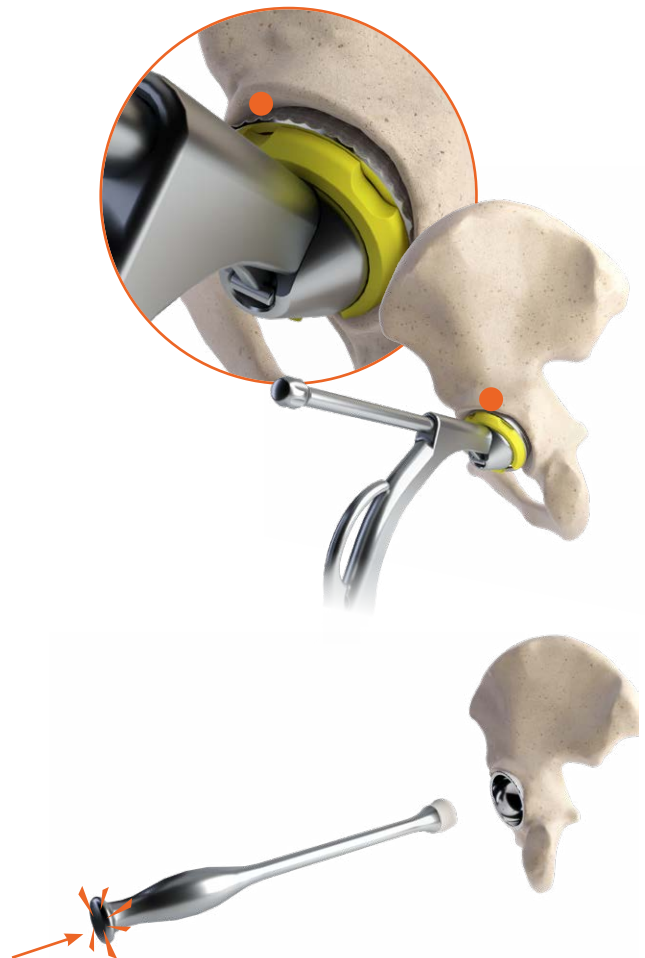

5 NOVAE® E TH OR COPTOS TH IMPLANTATION

The flanges of the **NOVAE® E TH** and **NOVAE® COPTOS TH** cups are pre-bent.

The angle of the curvature can be altered using the flange modeller included in the dedicated instrumentation set.

Mount the **NOVAE® E TH** cup (or **NOVAE® COPTOS TH** cup) on the gripper that is already fitted to the cup holder impactor that is the size of the definitive implant.

Present the cup in front of the acetabular cavity.

The notch on the cup holder impactor makes it possible to see the marker on the side of the implant that must be positioned towards the roof of the acetabulum.

The inclination/abduction of 45° and the anteversion (between 15 and 20°) should be checked prior starting impaction.

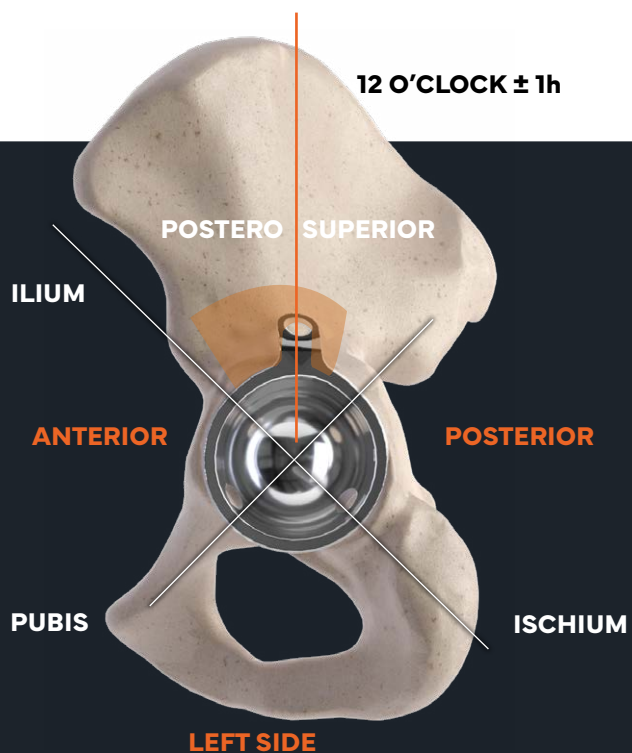

Positioning the definitive cup

Example :

For a left side in a lateral view, the cup flange must be positioned at twelve o'clock, plus or minus one hour, so that the peg holes are respectively opposite the ischium and the pubis. The flange or flanges (according to the cup chosen) are set against the iliac bone.

Impact the cup then open the lever to remove the impactor.

Pegs placement

The 2 pegs are sterile-packed with the **NOVAE® ETH** and **COPTOS TH** acetabular cups. Attach a flexible drill bit to the guide. The two holes are prepared immediately afterwards.

To do this, position the guide correctly in the hole and drill to the stop of the flexible drill bit. Hold the pegs with the peg-holder forceps.

A first peg is partly impacted then the second is put in place and both are pushed in alternately using a straight or curved handle. The pegs must be fully seated and must not exceed the inner surface of the cup.

Drilling and screw placement

The Ø 3.2 mm hole(s) is (are) made using the drill bit guide oriented towards the acetabulum roof in the posterosuperior quadrant. The drill bit must be angled upwards (at 45° relative to horizontal) and backwards as slant as the iliac wing allows.

- Drill to the inner edge of the 2nd cortex
- The drill is taken out and replaced by the depth gauge.

The depth is read and 5 mm will be added for the length of the screw.

Two hands are needed to drill the second cortex: one pushing, one holding back.

The condition of the drill must be checked prior to use and a high rotation speed is recommended (about 1000 tr/min). Drilling must be done carefully, particularly at the second cortex.

It is sometimes useful to alter the angle of the drill bit after going through the first cortex.

The drilling angle is preserved until the screw is put in place.

The Ø 5 mm sterile cortical screw can be inserted with a power drill bit and locking completed using a manual hexagonal screwdriver.

The pegs must be re-impacted after the screws are tightened.

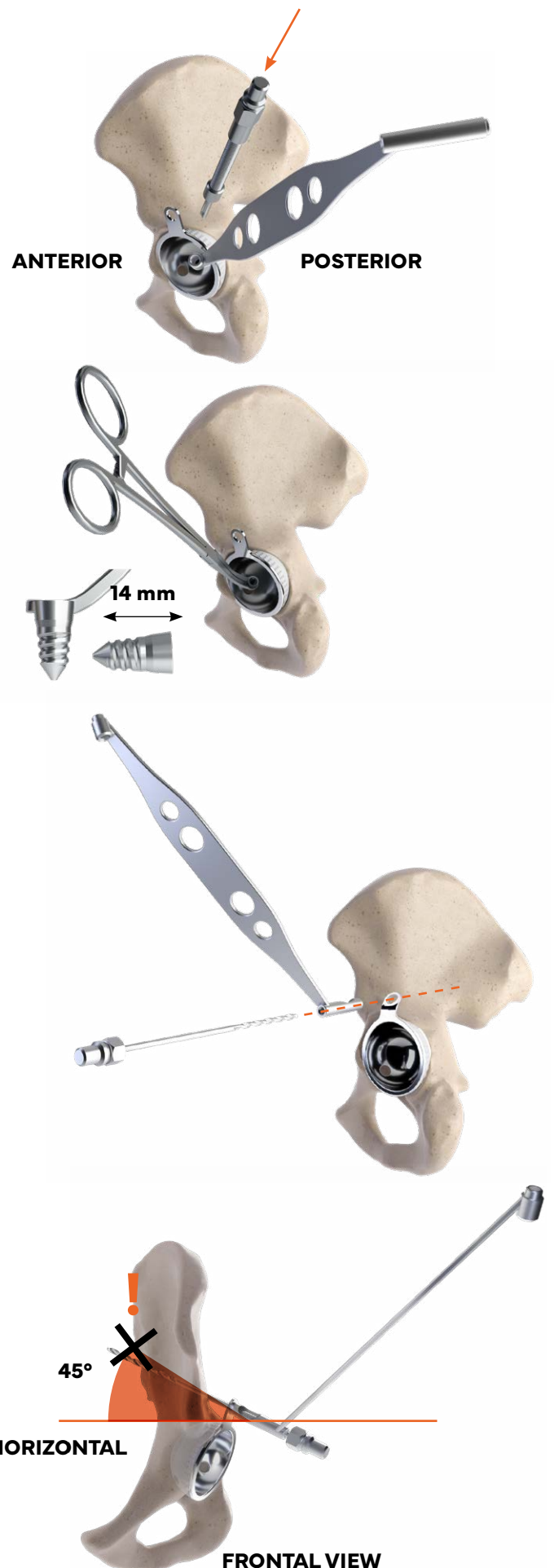

Trial reduction

The trial reduction can be done in the definitive cup. Mount the trial liner on the trial or definitive femoral head in place on the stem (or on the trial neck on the broach). Reduce the hip and test articular stability.

Then carry out the hip reduction by applying an axial traction to the leg and by pushing the liner into the bottom of the acetabular cup using the dual mobility impactor tip attached to its impactor handle. Carry out tests for stability, angular range, and leg length.

The definitive head will be chosen according to the results of these trials.

When the trials are completed, remove the trial implants (liner and head or just the liner) that are in place.



6 NOVAE® STICK IMPLANTATION

The **NOVAE® STICK** cup comes with a loose single-use polyethylene impaction plate. Mount the disposable impactor on the handle.

Put the cement at the back of the acetabulum then position the **NOVAE® STICK** cup in the acetabular cavity.

The inclination/abduction of 45° and the anteversion (between 15 and 20°) should be checked prior starting impaction.

Position the gripper (along with the disposable impactor that came with the cup) on the edge of the implant to hold it in place during cement polymerisation.

This impaction plate is not stuck into the cup to prevent micromovements of the cup in the cement while it is hardening.

The single-use impaction plate also prevents cement coming into contact with the polished surface of the **NOVAE® STICK** cup.

Once cement polymerisation is complete, remove the straight impactor handle and the impaction plate.

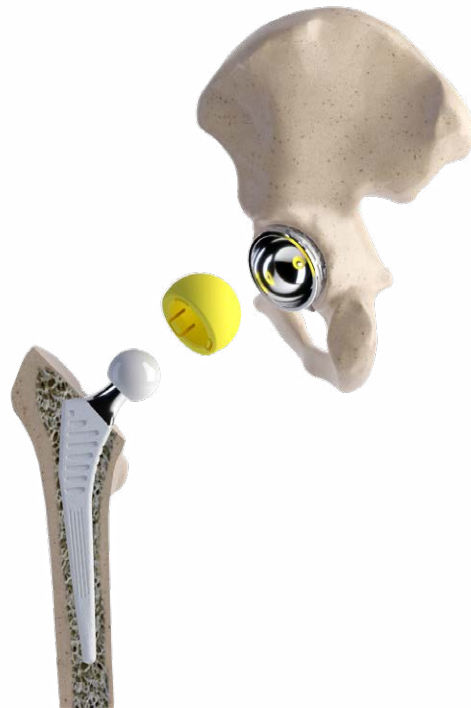

Trial reduction

The trial reduction is carried out in the definitive cup. Mount the trial liner on the trial femoral head (or the definitive one on the stem or on the trial neck broach).

Then carry out the hip reduction by applying an axial traction to the leg and by pushing the liner into the bottom of the acetabular cup using the dual mobility impactor tip attached to its impactor handle. Carry out tests for stability, angular range, and leg length.

The definitive head will be chosen according to the results of these tests.

When the tests are completed, remove the trial implants (liner and head or just the liner) that are in place.

7 ASSEMBLY OF THE LINER AND THE DEFINITIVE HEAD

ICJB E

There are two options:

- A** On table assembly
- B** In situ assembly

A On table assembly

Screw the black head supporting piece and the locking ring together centring them on the fork of the mobile liner impactor. Hold the impactor vertically on the table.

Avoid getting any liquids on the definitive head and definitive liner as this could make it impossible to reduce the head into the liner.

Place the head onto the head supporting piece and position the liner on the head.

A second supporting metallic piece is supplied in addition to the head supporting piece.

Start to tighten the press to reduce the head into the liner whilst keeping the polyethylene liner in the axis of the impactor cone when the piston goes down.

The head is fully impacted into the liner when the retention area has been passed, and when the head is fully mobile in the liner.

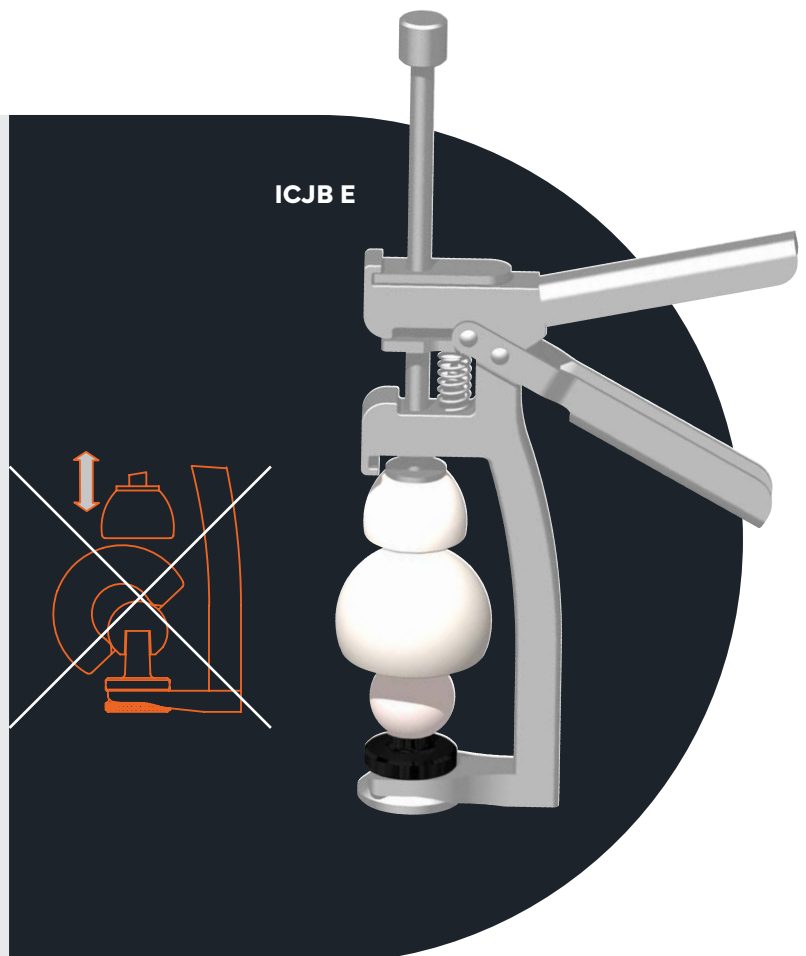
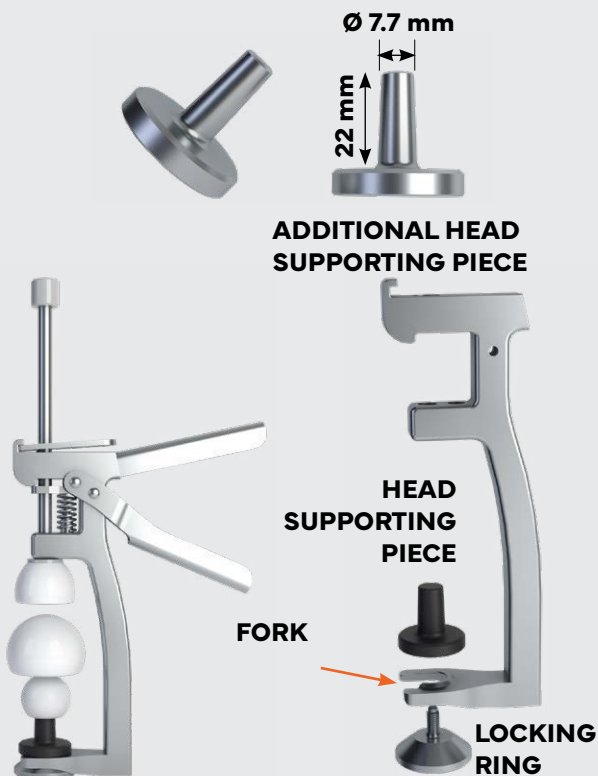

B In situ assembly

Position the impactor fork below the implant head (neck \varnothing 13 max).
Place and hold the liner in the axis of the neck at moment of full impaction (final air release).

Unlocking the impactor

Once the head and the liner are assembled, unlock the impactor by pressing on the brake.

Pull the stem back to free the liner.
Check mobility of the head in the polyethylene liner thoroughly after impaction.

SERF declines any liability in case of association with competing products as we cannot guarantee their compatibility.

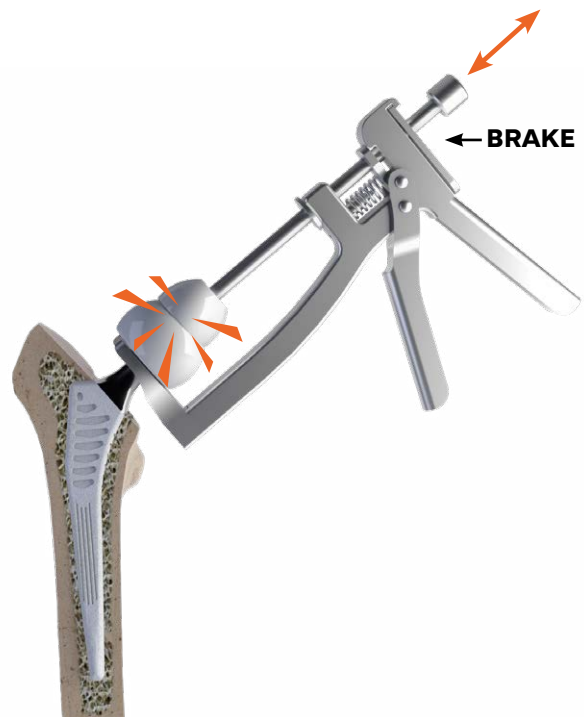

CLICKER®

Place the femoral head on the cone and position the liner of the determined size on the centering device.

Start tightening the handle to reduce the head into the liner.

The liner is retained and will be centered automatically as the press is lowered, thanks to the pushing tip.

To release the head and liner assembly, lower the Clicker® carriage and retrieve the assembled implants. The head is perfectly impacted in the liner as soon as the retention zone is passed, this is materialized by the passage of «two overthicknesses».



8 IMPACTION AND DEFINITIVE REDUCTION

Assemble the impactor tip on the gripper/ impactor handle.

Position the femoral head and liner assembly in the cone of the definitive femoral stem, then proceed with impaction using the impactor tip with its impactor handle.

Then carry out the hip reduction by applying an axial traction to the leg and by pushing the liner into the bottom of the acetabular cup using the dual mobility impactor tip attached to its impactor handle.

Carry out tests for stability, angular range, and leg length.



Revision cases

PEGS EXTRACTION FOR NOVAE® E TH AND COPTOS TH

- A** Screw the peg extractor into the thread in the peg until it is extracted.
- B** Take out the first peg and do the same to extract the second one.





EXTRACTION OF THE MOBILE LINER

- 1 Place the appropriately sized trial cup on the liner in place
- 2 Turn the liner so that the notch on it (point A on page 13 of this document) is exposed and is accessible. Insert the liner extractor into this notch.
- 3 Lever it to pull out the liner



Warning:

The liner cannot be resterilized once removed and must be disposed of with infectious healthcare waste (in accordance with the regulation in force).



INSTRUMENTATION

NOVAE® ETH, SUNFIT TH, COPTOS TH & STICK VARANX01 – TRAY 1

Option « ICJBE »

N°	REFERENCE	DESIGNATION
1	FT 43 to FT 65	Reamer Ø 43 to Ø 65
2	ET	Reamer adaptor
3	TFT-AO	Reamer handle
4	EI016	Cup impactor
5	EI015	Liner impactor
6	MI 603	Impaction shaft

Option « ICJBE »

7	ICJB E	Liner head impactor
8	CA701	Hexagonal angled wrench Ø 6 mm
9	OR COJB 8 COJB 75 M	Plastic press support taper Ø 8 mm Metal press support taper Ø 7.5 mm

Option « CLICKER »

10	CLICKER	Clicker liner head impactor
11	CLICKER SOCLE	

Optional additional instruments included in the kit:

12	JBG-3	ICJB E handle	OPTION
13	EXT007	Trial cup extractor	OPTION

Optional additional instruments delivered in a separate bag:

14	MP009	Minimally invasive gripper shaft for NOVAE® STICK	OPTION
15	MP020L	Straight gripper shaft	OPTION



Option « CLICKER »

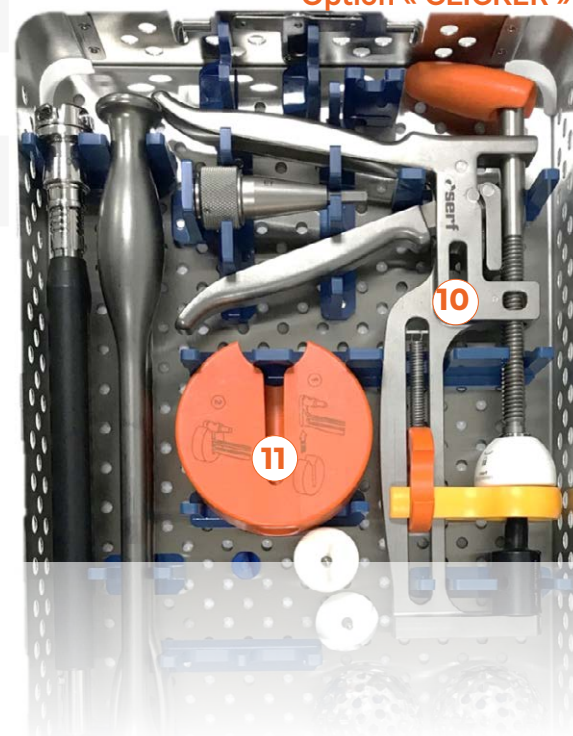

NOVAE® ETH, SUNFIT TH, COPTOS TH & STICK

VARANX01 – TRAY 2

N°	REFERENCE	DESIGNATION
1	OR IE006 43/22.2 to IE006 65/28 IR43/22.2 to IR65/28	Trial liner 22.2 43 to 28 65 Retentive trial liner Ø 43 / Ø 65 for head Ø 22.2 / Ø 28
2	GE007-43 to GE007-65	Trial cup 43 to Trial cup 65
3	OR ADA22-28 AR22-28	Trial liner adaptor Ø 22.2 / Ø 28 Retentive trial liner adaptor Ø 22.2 / Ø 28
4	MP010 TIV009	Minimally invasive gripper shaft Guide rod
5	PC-43 to PC-65	Cup holder adaptor Ø 43 / Ø 65
6	ECM 8	Liner remover
7	PPN E	Peg forceps
8	EXTPCJ	(PCJ) Disposable cup gripper extractor

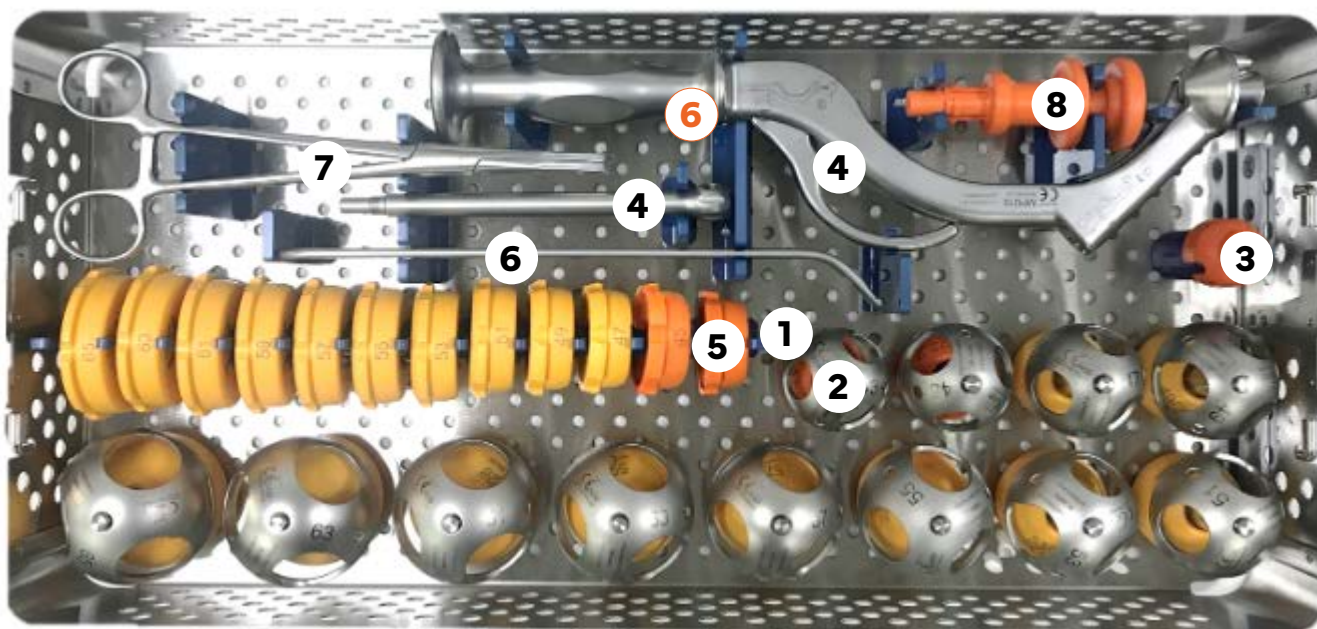

NOVAE® ETH & COPTOSTH

ADDITIONAL INSTRUMENTS SETS - PEGS AND SCREWS VARAIY01

N°	REFERENCE	DESIGNATION
1	EPMP6	Peg extractor / 6 mm hex wrench / Flange modeller
2	IPCN	Straight peg impactor
3	IPCNC	Curved peg impactor
4	MV700	Depth gauge
5	TMA 3.5 E	3.5 mm manual hexagonal screwdriver
6	GM 3.2-5 E	Drill guide for Ø 3.2 mm
7	TMO 3.5	3.5 mm motorised hexagonal screw driver
8	F 3.2-150 E	Ø 3.2 mm screw drill
9	MF 5 E	Ø 5 mm flexible drill bit



ACCESS TO THE DIGITAL INSTRUCTION FOR USE

SERF offers, for each type of implant, dematerialized Instructions for Use (IFU) regularly updated, and easy to download and to print according to your needs.

You will find in these IFU not only the regulatory information and technical specifications of our implants, but also valuable information on indications, contraindications, and compatibilities between implants, etc.

These dematerialized instructions, provided in PDF format, are available and downloadable via two ways:

- from a QR code on the packaging of the implant, which can be read using a smartphone or tablet (requires Internet connection, 3G / 4G, WiFi ...) and an application appropriate reading (available for free download on Google Play, Apple® AppStore and Windows® Store according to the device used)
- with an Internet connection via a PC, smartphone or tablet, typing directly the URL address written near the QR code, to your usual Internet browser's.

Here are the QR code and URL address of the dematerialized IFU covering the **XPEO-E LINER** range presented in this document:



<http://doc.serf.fr/0927.pdf>

For all other NOVAE® acetabular components presented in this document except XPEO-E liner, please refer to the paper version of the IFU available in the implants' packaging.

Acrobat Reader DC Operating System required

Windows

- 1.5 GHz processor or faster
- Windows Server 2008 R2 (64 bits), 2012 (64 bits), 2012 R2 (64 bits)* or 2016 (64 bits); Windows 7 SP1 (32 and 64 bits), Windows 8, 8.1 (32 and 64 bits)* or Windows 10 (32 and 64 bits)
- 1 Gb of RAM
- 380 Mb of free disk space
- 1024x768 screen resolution
- Internet Explorer 11

MacOS

- Intel processor
- Mac OS X v10.11, macOS v10.12, macOS v10.13 or macOS v10.14*
- 1 Gb of RAM
- 380 Mb free disk space
- 1024x768 screen resolution
- Safari 9.0, 10.0 or 11.0 (The plug-in for Safari is supported only by 64-bit systems with an Intel processor).

Mobile application

- Adobe Acrobat Reader: iOS, Android, Windows Phone
- Adobe Scan: iOS, Android
- Adobe Fill & Sign: iOS, Android

CAUTION: Federal Law (USA) restricts this device to sale by or on the order of a physician.

Only for distribution within the USA.

Before using a SERF product, please refer to the instruction leaflet and to the surgical technique. Please refer to the labels, instructions for use and surgical technique for the complete list of indications, contraindications, risks, warnings, precautions and directions for use. For further information please contact your SERF's local distributor.

©2023 SERF. All rights reserved. NOVAE® is a trademark of SERF.

DISTRIBUTED BY



SERF 85 avenue des Bruyères, 69150 Décines-Charpieu - FRANCE
Tel. +33 (0)4 72 05 60 10 - Fax +33 (0)4 72 02 19 18 / serf@serf.fr
For complaint: complaint@serf.fr



 serf